

Machines
and Tools
for Pipework

01/2015

Promotion

A WORLD FIRST

**REMS Multi-Push also for
disinfection of drinking water
installations in accordance
with EN 806-4:2010**
(see page 3)



REMS

for Professionals



German quality product

Tripod (accessory)

REMS Python – save expensive fittings. Super easy bending up to Ø 2", Ø 75 mm.

REMS Python

Hydraulic pipe bender for dimensionally accurate bending of pipes up to 90°. Steel pipes EN 10225 Ø ¾–2", multilayer composite tubes Ø 32–75 mm. Bender drive with back former supports and back formers, bending formers St and V.In sturdy transport case.

for steel pipes

Set St ¾ - 1/2 - ¾ - 1 - 1¼"

Art. No. 590020 £ 960.00

for steel pipes

Set St ½ - ¾ - 1 - 1¼ - 1½ - 2"

Art. No. 590021 £ 1,060.00

for multilayer composite tubes

Set V 40 - 50 - 63 mm

Art. No. 590022 £ 980.00

£ **869.00**

£ **959.00**

£ **939.00**

Tripod

Art. No. 590150

£ **101.00**

Bending former and back formers 75 mm

Art. No. 590063

£ **399.00**

REMS Curvo – Bending pipes without creasing up to Ø 40 mm, 180°. Without vice. Ready to use immediately without setting.



1000 W – only 8 kg

German quality product

Bending instead of expensive fittings!
The cost of REMS Curvo is recovered just after a few bends.

REMS Curvo Basic-Pack

Electric pipe bender Ø 10–40 mm, Ø ¼–1¾", up to 180°. Hard, semi-hard, soft copper pipes, also thin-walled, Ø 10–35 mm, Ø ¼–1¾", soft jacketed copper pipes, also thin-walled, Ø 10–18 mm, pipes of the press fitting systems made of stainless steel Ø 12–28 mm, carbon steel, also jacketed, Ø 12–28 mm, soft precision steel pipes Ø 10–28 mm, steel pipes DIN EN 10255 Ø ¼–¾", electrical installation pipes EN 50086 Ø 16–32 mm, multilayer composite tubes Ø 14–40 mm, among other things drive machine with maintenance-free gear with safety slip clutch, 110 V, 50–60 Hz, 1000 W universal motor, continuous, electronic safety switch, right and left-hand rotation. Fast and creep speed for precise bending. Insert bolt.

Bending and back formers. In sturdy steel case.

Art. No. 580010 £ 890.00

£ **709.00**

REMS Curvo 50 – wrinkle free bending of large pipes.



REMS Curvo 50 Basic-Pack

Electric pipe and tube bender Ø 10–50 mm, up to 90°. Steel pipes EN 10225 Ø ¼–1¼", hard, half-hard and soft copper tubes, Ø 10–42 mm, thin-wall copper tubes Ø 10–35 mm, pipes of the press fitting systems made of stainless steel Ø 12–42 mm, carbon steel Ø 12–35 mm, carbon steel coated Ø 12–28 mm, multi-layer composite tubes Ø 14–50 mm and others. In sturdy steel case.

Art. No. 580110 £ 2,130.00

£ **1,699.00**

Bending formers and back formers

Bending formers and back formers, 180°, form and pressure resistant, in highstrength, high-slide, glass-fibre reinforced polyamide 90° (Ø 35 R 100, Ø 42 R 140, Ø 50 R 135, Ø 1" R 100, Ø 1¼" R 140). Optimum mating of bending formers and back formers ensures sliding appropriate to the material without cracks and wrinkles. Angle scale provided on each bending former and mark on the back former ensure precise bending. Rapid change of bending formers and back formers.

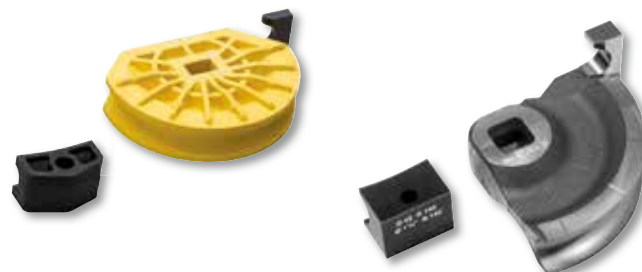

List price **–20 %**

A WORLD FIRST

Flushing

Flushing of drinking water installations with water or with a water/air mixture with intermittent compressed air in accordance with EN 806-4:2010 and information leaflet T 84-2004 "Flushing, Disinfection and Commissioning of Drinking Water Installations" (August 2014) of the German Central Association for Sanitary, Heating and Air Conditioning (ZVSHK) and for flushing of radiators and area heating systems. Also for flushing pipe systems with a water/air mixture with constant compressed air.

Disinfection

Disinfection unit TW for the disinfection of drinking water installations in accordance with EN 806-4:2010 and information leaflet "Flushing, Disinfection and Commissioning of Drinking Water Installations" (August 2014) of the German Central Association for Sanitary, Heating and Air Conditioning (ZVSHK) and other pipe systems, as an accessory.

Cleaning and preservation

Cleaning and preservation unit H for cleaning and preserving heating systems, as an accessory.

Pressure and leak testing with compressed air

Leak testing of drinking water installations with compressed air in accordance with information leaflet T 82-2011 "Leak Testing of Drinking Water Installations" (January 2011) of the German Central Association for Sanitary, Heating and Air Conditioning (ZVSHK) and pressure and leak testing of other pipe systems and vessels.

Load testing of drinking water installations with compressed air in accordance with information leaflet T 82-2011 "Leak Testing of Drinking Water Installations" (January 2011) of the German Central Association for Sanitary, Heating and Air Conditioning (ZVSHK) and pressure and leak testing of other pipe systems and vessels.

Pressure and leak testing with water (SLW)

REMS Multi-Push SLW with hydro-pneumatic water pump for hydrostatic pressure testing of drinking water installations with water in accordance with EN 806-4:2010, test method A, B or C or test method B, modified in accordance with information leaflet T 82-2011 "Leak Testing of Drinking Water Installations" (January 2011) of the German Central Association for Sanitary, Heating and Air Conditioning (ZVSHK) and for pressure and leak testing of other pipe systems and vessels.

Compressed air pump

Compressed air pump for controlled filling of all types of vessels with compressed air ≤ 0.8 MPa/8 bar/116 psi, with automatic switch-off on reaching the preset air pressure, e.g. for pumping up expansion vessels or tyres.

Operation of compressed air tools

Connection for compressed air tools up to an air requirement ≤ 230 NI/min, adjustable, for adaptation to the used compressed air tool. Pressure gauge for controlling the air pressure supplied by the compressed air tank. Compressed air hose with quick coupling NW 7.2, as an accessory.

Logging

Results of the flushing and test programs are saved with date, time and log number in the selected language and can be transferred to USB stick or printer for documentation. Additions to saved data, e.g. customer name, project number, tester, are possible on external devices (e.g. PC, laptop, tablet-PC, Smartphone).

REMS Multi-Push – only one device with more than 10 programs for flushing and pressure testing with compressed air or water of drinking water and heating installation among other things.

Very easy menu guidance in 26 languages

Permanent process monitoring

Logging

USB interface

**EN 806-4
ZVSHK¹⁾**

REMS Multi-Push SL Set

Electronic flushing and pressure testing unit with oil-free compressor. For flushing with water or a water/air mixture, disinfection, cleaning, preservation of pipe systems, for pressure and leak testing of pipe systems and vessels with compressed air, as a compressed air pump for controlled filling of all types of vessels with compressed air $p \leq 0.8$ MPa/8 bar/116 psi, and for operation of compressed air tools ≤ 230 NI/min Input and control unit Piston compressor with crank drive, capacitor motor 230 V, 50 Hz, 1,500 W. Person circuit breaker (PRCD). 2 suction/pressure hoses 1", 1.5 m long, with 1" hose screw fittings, 1 compressed air hose 8 mm, 1.5 m long, with DN 5 quick coupling, for pressure testing with compressed air. Seals for inputs and outputs. Mobile tubular steel frame. Without feeder unit for additives. In a carton.

Art. No. 115610 £ 2,090.00

£ **1,749.00**

REMS Multi-Push SLW Set

Like Art. No. 115610, but with additional hydropneumatic water pump and 1/2" high pressure hose, 1.5 m long, with 1/2" hose fittings for pressure and leak testing of pipe systems and vessels with water. Seals for inputs and outputs.

Art. No. 115611 £ 2,600.00

£ **2,099.00**

Disinfection unit TW

for drinking water installations, for feeding dosing solution for disinfection.

Art. No. 115602

£ **182.00**

Cleaning and preservation unit H

for heating systems, for feeding cleaning agent and corrosion protection.

Art. No. 115612

£ **182.00**

USB printer

for printing the saved results of the flushing and test programs

Art. No. 115604

£ **264.00**



* Free software update for REMS Multi-Push SL/SLW under www.rems.de → Downloads → Software

¹⁾ Leak testing of drinking water installations with compressed air in accordance with information leaflet "Leak Testing of Drinking Water Installations" (January 2011) of the German Central Association for Sanitary, Heating and Air Conditioning (ZVSHK). Disinfection of drinking water installations in accordance with EN 806-4:2010 and information leaflet "Flushing, Disinfection and Commissioning of Drinking Water Installations" (August 2014) of the German Central Association for Sanitary, Heating and Air Conditioning (ZVSHK).

REMS Solar-Push – filling, flushing and venting in one action. Self priming. High displacement. Ideal for solar power systems, ground heat systems and underfloor heating.

Easy cleaning and simple filling thanks to large opening in the plastic container.

Two practical handles for easy carrying of the plastic container.

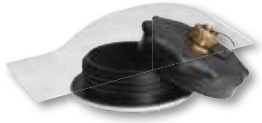

German quality product

REMS Solar-Push K 60

Transport volume ≤ 36 l/min, tank volume 30 l. With centrifugal pump, temperature-resistant for continuous load $\leq 60^\circ\text{C}$. Transport pressure ≤ 0.55 MPa/5.5 bar/80 psi. Condenser motor 230 V / 110 V, 50 Hz, 860 W. 2 pieces flexible, transparent PVC fabric hoses $\frac{1}{2}$ " T60, each 3 m long, temperature-resistant $\leq 60^\circ\text{C}$. In a carton.
Art. No. 115312 £ 550.00

£ **475.00**

REMS Solar-Push I 80

Electric filling and flushing unit for easy and fast filling, flushing and venting of closed systems. Pumping capacity ≤ 27 litres/min, tank volume 30 litres. With impeller pump, temperature resistant during constant use $\leq 80^\circ\text{C}$. Pumping pressure ≤ 0.65 MPa/6.5 bar/94 psi. Capacitor motor 230 V, 50 Hz, 1000 W. Pressure release valve. 2 flexible EPDM-fabric hoses $\frac{1}{2}$ " T100, 3 m long, high temperature resistant $\leq 100^\circ\text{C}$. In a carton.
Art. No. 115311 £ 660.00

£ **539.00**



Fine filter with fine filter bag 70 μm

consisting of screw cap with return connection for return line with $\frac{3}{4}$ " union, adapter, 1 fine filter bag 70 μm , for flushing underfloor heating/wall radiators and clearing sludge
Art. No. 115220

£ **56.50**

Fine filter with fine filter cartridge 90 μm

washable, with large dirt collection vessel, for return line with $\frac{3}{4}$ " union, for flushing underfloor heating/wall radiators and clearing sludge
Art. No. 115323

£ **132.00**

Changeover valve flow direction

complete with EPDM fabric hose $\frac{1}{2}$ " T100, for flushing underfloor heating/wall radiators and effective clearance of sludge by pressure surges when flow direction changes
Art. No. 115326

£ **175.00**

REMS Push – reliably tight.

Brass pressure piston



Tank volume 12 l
up to 60 bar

REMS Push

Manual pressure testing pump with pressure gauge, $p \leq 6$ MPa/60 bar/870psi, for pressure and leak testing of pipe systems and tanks up to 6 MPa/60 bar/870psi. Corrosion-resistant, powder-coated sheet steel tank for 12 l. 1.5 m high-pressure hose with $\frac{1}{2}$ " connection. In a carton.

Art. No. 115000 £ 169.00

£ **139.00**



Stainless steel tank

REMS Push INOX

Manual pressure testing pump with pressure gauge, $p \leq 6$ MPa/60 bar/870psi, for pressure and leak testing of pipe systems and tanks up to 6 MPa/60 bar/870psi. Stainless steel tank for 12 l. 1.5 m high-pressure hose with $\frac{1}{2}$ " connection. In a carton.

Art. No. 115001 £ 251.00

£ **195.00**

REMS Pull-Push – fast removal of blockages.

High downforce thanks to front adjustable grip handle.

2 adaptor sleeves for optimum adaptation to the problem area: Short sleeve for sinks, basins and baths, long sleeve for toilets.



REMS Pull-Push

Manual suction / pressure pump for fast removal of blockages.

With short and long sleeves. In a carton.

Art. No. 170300 £ 105.00

£ **79.00**

REMS E-Push 2 – electrical filling and testing.

High-pressure hose with fabric inlay prevents falsification of the measuring result.

High-pressure reciprocating pump

High displacement of 6.5 l/min

Adjustable pressure limiting

Suction hose with suction filter



Up to 60 bar 1,300 W.

Self priming.

REMS E-Push 2

Electric pressure testing pump with pressure gauge for pressure and leak testing of pipe systems and tanks up to 6 MPa/60 bar/870 psi, with adjustable pressure limiting. Pump unit with condenser motor 110 V / 230 V, 50 Hz, 1,300 W. 1.5 m suction hose with 1/2" connection. 1.5 m high-pressure hose with 1/2" connection. Return trap. In a carton.

Art. No. 115500 £ 570.00

£ **475.00**

With automatic spiral feed and return



0–550 rpm
600 W, only 5.2 kg

REMS Mini-Cobra A

Electric pipe cleaning device with automatic spiral feed and return, for pipes Ø 20–50 (75) mm.

For pipe cleaning spirals Ø 8 and 10 mm. Drive machine with maintenance-free gear, 110 V / 230 V, 50–60 Hz, 600 W universal motor, extra torque powerful left and right-hand rotation at low speeds, safety switch. Stepless, electronic speed control (accelerator switch). Spiral drum made of impact-resistant, glass fibre-reinforced plastic. Coil Ø 8 mm, with core, 7,5 m long. In sturdy steel case.

Art. No. 170021 £ 487.00

German quality product

£ **385.00**

Proven, handy device for quick action in case of blocked pipes in the kitchen, bathroom and toilet.



German quality product

REMS Mini-Cobra

Pipe cleaning device for pipes Ø 20–50 (75) mm, with crank handle and hexagonal driver for conventional drive machine (electric, slow drilling machine with continuous drive or power drill/screwdriver). For pipe cleaning spirals Ø 6, 8 and 10 mm. Spiral drum made of impact-resistant, glass fibre-reinforced plastic. Quick-clamping chuck. Coil Ø 8 mm, 7,5 m long. In a carton.

Art. No. 170010 £ 118.00

£ **95.00**

German quality product



REMS Cobra – Pipe free – quick and easy.

Fast rotator with spiral sections for working lengths up to 70 m. Effective chain spinning and cutting up to 740 rpm.

Closed drive spindle protects motor and drive against dirt and water.

REMS Cobra 22 Set 16+22

Electric pipe cleaning machine for pipes Ø 20–150 mm. Drive machine with maintenance-free toothed belt drive, 230 V, 50 Hz, 750 W condenser motor, right and left-hand rotation, guide hose. Personal protection switch (PRCD). 5 spiral sections 16 × 2.3 m in the spiral cage, straight drill 16, club drill 16, toothed blade drill 16/25, spiral cutting pin 16, 5 spiral sections 22 × 4.5 m in the spiral cage, straight drill 22, recovery drill 22, funnel drill 22, toothed cross blade drill 22/35, spiral cutting pin 22/32, 2 pairs of guide gloves, steel case for every tool kit. In a carton.

Art. No. 172012 £ 1,510.00

£ **1,099.00**

**REMS Puma VE – the powerful universal saw with anti-vibration system.
Quick saw blade change without tools.
Adjustable support shoe.**

Saw blade can be inserted turned 180°.



1300 W – 3.8 kg

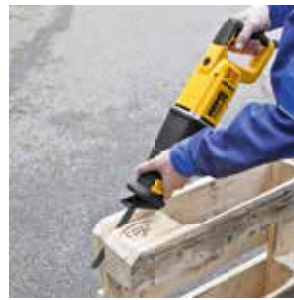

REMS Puma VE Set

Electric universal reciprocating saw with Vario-Electronics (VE) for free hand sawing, with anti-vibration system. Drive machine with D-shaped handle with soft grip, maintenance-free oscillation drive, powerful 230 V, 50–60 Hz, 1,300 W universal motor, safety switch, connecting cable 4 m. Continuous electronic stroke speed control (accelerator switch) 0 to 2,800 rpm. 30 mm stroke. Saw blade holder with quick-change system. Adjustable support shoe. 1 REMS saw blade 210-1.8/2.5. In sturdy steel case.
Art. No. 560023 £ 254.00

£ **199.⁰⁰**

REMS saw blades for metal

→ REMS Puma, REMS Cat, REMS Akku-Cat, REMS Tiger, etc.



Designation	Length mm	Tooth pitch mm	Material*	Teeth	Quantity pieces	Art. No.	List price £
REMS saw blade 150-1 sheet metal, metal, also stainless steel, ≥ 1.2 mm	150	1	HSS-Bi flexible	corrugated	5	561105	16.60
REMS saw blade 200-1 sheet metal, metal, also stainless steel, ≥ 1.2 mm	200	1	HSS-Bi flexible	corrugated	5	561106	21.70
REMS saw blade 90-1.4, curved blade metal, also stainless steel, ≥ 1.5 mm	90	1.4	HSS-Bi	corrugated	5	561107	13.80
REMS saw blade 150-1.4 metal, also stainless steel, ≥ 1.5 mm	150	1.4	HSS-Bi flexible	corrugated	5	561104	17.30
REMS saw blade 200-1.4 metal, also stainless steel, ≥ 1.5 mm	200	1.4	HSS-Bi flexible	corrugated	5	561108	21.70
REMS saw blade 100-1.8 metal, also stainless steel, ≥ 2 mm	100	1.8	HSS-Bi flexible	corrugated	5	561101	14.80
REMS saw blade 150-1.8 metal, also stainless steel, ≥ 2 mm	150	1.8	HSS-Bi flexible	corrugated	5	561103	17.30
REMS saw blade 200-1.8 metal, also stainless steel, ≥ 2 mm	200	1.8	HSS-Bi flexible	corrugated	5	561102	21.70
REMS saw blade 200-2.5 metal, also stainless steel, ≥ 3 mm	200	2.5	HSS-Bi flexible	straight-set	5	561109	21.70
REMS saw blade 280-2.5 metal, also stainless steel, ≥ 3 mm	280	2.5	HSS-Bi flexible	straight-set	5	561112	27.40

REMS saw blades for wood and metal

→ REMS Puma, REMS Cat, REMS Akku-Cat, REMS Tiger, etc.



Designation	Length mm	Tooth pitch mm	Material*	Teeth	Quantity pieces	Art. No.	List price £
REMS saw blade 210-1.8/2.5 round tip, no sticking pallets, wood, wood with nails, metal ≥ 2.5 mm	210	Combo 1.8/2.5	HSS-Bi flexible	straight-set	5	561113	22.70
REMS saw blade 150-2.5 wood, wood with nails, pallets, metal ≥ 3 mm	150	2.5	HSS-Bi flexible	straight-set	5	561110	16.60
REMS saw blade 225-2.5 , extra thick, for disassembly wood, wood with nails, metal ≥ 3 mm	225	2.5	HSS-Bi	corrugated	3	561114	21.30
REMS saw blade 300-2.5 , extra thick, for disassembly wood, wood with nails, metal ≥ 3 mm	300	2.5	HSS-Bi	corrugated	3	561116	28.30
REMS saw blade 300-4.2 wood	300	4.2	WS	straight-set	5	561111	20.00
REMS saw blade 225-3.2/5.0 wood, wood with nails	225	Combo 3.2/5.0	HSS-Bi flexible	straight-set	5	561117	25.20
REMS saw blade 290-5.0/6.35 green wood	290	Combo 5.0/6.35	WS	straight-set	5	561118	27.30
REMS saw blade 150-6.35 wood	150	6.35	WS	straight-set	5	561119	11.60

REMS saw blades for different purposes

→ REMS Puma, REMS Cat, REMS Akku-Cat, REMS Tiger, etc.



Designation	Length mm	Tooth pitch mm	Material*	Teeth	Quantity pieces	Art. No.	List price £
REMS saw blade 150-4.2 breeze blocks, plasterboard	150	4.2	WS	straight-set	5	561115	14.40
REMS saw blade 225-8.5 breeze blocks, hard wood	225	8.5	HM	straight-set	1	561120	37.70
REMS saw blade 300-8.5 breeze blocks, hard wood	300	8.5	HM	straight-set	1	561121	45.00
REMS saw blade 400-8.5 breeze blocks, hard wood	400	8.5	HM	straight-set	1	561122	64.40
REMS saw blade 235-12 breeze blocks, pumice, brick	235	12	HM	straight	1	561123	52.10
REMS saw blade 300-12 breeze blocks, pumice, brick	300	12	HM	straight	1	561124	60.40
REMS saw blade 300-12 , extra high blade breeze blocks, pumice, brick	300	12	HM	straight	1	561125	71.80
REMS saw blade 200 cast iron etc.	200		HM-G		2	561126	21.40

REMS special saw blades

→ REMS Tiger, etc.



REMS

Designation	Ø Zoll/ Length mm	Tooth pitch mm	Material*	Teeth	Quantity pieces	Art. No.	List price £	Promotion price £
REMS special saw blade 2"/140-2.5 steel pipes ≤ 2"	2"/140	2.5	HSS-Bi	corrugated	5	561007	39.60	28.80
REMS special saw blade 2"/140-3.2 steel pipes ≤ 2"	2"/140	3.2	HSS-Bi	corrugated	5	561001	37.60	28.40
REMS special saw blade 4"/200-3.2 steel pipes ≤ 4"	4"/200	3.2	HSS-Bi	corrugated	5	561002	50.10	33.90
REMS special saw blade 6"/260-3.2 steel pipes ≤ 6"	6"/260	3.2	HSS-Bi	corrugated	5	561008	63.60	59.00

For materials that are difficult to cut, e.g. stainless steel pipes, hard cast iron pipes, instead of the REMS special saw blade the fine-toothed REMS universal saw blade in connection with REMS Tiger ANC SR with electronic stroke number regulation. *HSS-Bi: bimetal high speed steel

REMS universal saw blades

→ REMS Tiger, REMS Cat, REMS Akku-Cat, etc.



REMS

Designation	Length mm	Tooth pitch mm	Material*	Teeth	Quantity pieces	Art. No.	List price £	Promotion price £
REMS universal saw blade 100-1.8/2.5 for all sawing work	100	Combo 1.8/2.5	HSS-Bi flexible	straight-set	5	561006	25.90	20.10
REMS universal saw blade 150-1.8/2.5 for all sawing work	150	Combo 1.8/2.5	HSS-Bi flexible	straight-set	5	561005	36.70	26.30
REMS universal saw blade 200-1.8/2.5 for all sawing work	200	Combo 1.8/2.5	HSS-Bi flexible	straight-set	5	561003	48.90	34.50
REMS universal saw blade 300-1.8/2.5 for all sawing work	300	Combo 1.8/2.5	HSS-Bi flexible	straight-set	5	561004	72.10	45.00

Also for wood with nails, pallets. For materials that are difficult to cut, e.g. stainless steel, hard cast iron, a low stroke number is necessary, e.g. by REMS Tiger ANC SR with electronic stroke number regulation. *HSS-Bi: bimetal high speed steel

REMS Cat ANC VE – saws everything anywhere. Extremely versatile and powerful. Robust and handy.



German quality product

1050 W – 3.0 kg

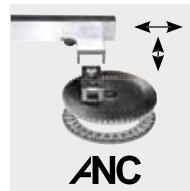

ANC – for maximum stress

REMS Cat ANC VE Set

Electric universal reciprocating saw with Vario Electronics (VE) for free-hand sawing. Drive unit with spade handle, maintenance-free, water and dust proof oscillation drive with all-round needle bearing crank drive (ANC), aggressive orbital stroke, powerful 110 V, 50–60 Hz, 1050 W universal motor, safety switch. Stepless electronic speed control (accelerator switch) 0–2400 rpm. Universal saw blade holder. Allen key. 1 REMS universal saw blade 150-1,8/2,5. In sturdy steel case.

Art. No. 560040 £ 364.00

£ **269.00**

REMS Tiger ANC – the pipe reciprocating saw. Saws easily, fast and at right angles.

Fixed, optimum number of strokes especially for sawing steel pipes.



Guide holder for 400 % more sawing power

German quality product

1050 W – only 3 kg

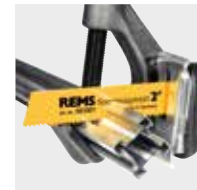
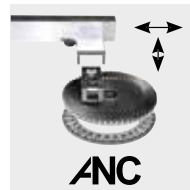

ANC – for maximum stress

REMS Tiger ANC Set

Electric pipe reciprocating saw for fast, easy, right-angled sawing with guide holder and for free-hand sawing. Drive unit with straight machine handle, maintenance-free, water and dust proof oscillation drive with all-round needle bearing crank drive (ANC), aggressive orbital stroke, powerful 110 V, 50–60 Hz, 1050 W universal motor, safety switch. Fixed number of strokes 2400 rpm. Overload protection. Universal saw blade holder. Allen key. Guide holder up to 2". 2 REMS special saw blades 2"/140-3,2. In sturdy steel case.

Art. No. 560020 £ 464.00

£ **389.00**

REMS Tiger ANC SR – with Speed-Regulation. Saws easily, quickly and at right angles.

Stepless electronic speed control.
Also ideal for sawing stainless steel pipes.
With speed generator.



Guide holder for 400 % more sawing power

German quality product

1400 W – 3.1 kg

ANC – for maximum stress

REMS Tiger ANC SR Set

Electric pipe reciprocating saw with Speed Regulation (VE) for fast, easy, right-angled sawing with guide holder and for free-hand sawing. Drive unit with straight machine handle, maintenance-free, water and dust proof gear with all-round needle bearing crank drive (ANC), fixed orbital stroke, powerful 110 V, 50–60 Hz, 1400 W universal motor, safety switch. Stepless electronic speed control 700–2200 rpm with sensitive start-sawing, speed generator, temperature monitor and stall protection. Universal saw blade holder. Allen key. Guide holder up to 2". 2 REMS special saw blades 2"/140-3,2. In sturdy steel case.

Art. No. 560026 £ 550.00

£ **455.00**

REMS Jumbo E – handy and light.



Work plate 800×600 mm
Working height 800 mm
Weight 23 kg
Load capacity ≤ 300 kg

REMS Jumbo E – assembled and disassembled at lightning speed.

Folding workbench with toggle catch. Work plate in accordance with DIN 68 705. In a carton.
Art. No. 120240 £ 182.00

£ **139.00**

Guide holder for REMS Tiger etc.

Unique guide holder with five-fold force transmitting leverage allows effortless, fast, right angled sawing everywhere on site, without a vice. Ideal handling, very quick and easy operation, only one handle for clamping and sawing. In a box



Guide holder up to 4"

Guide holder 2½–4"
Art. No. 563100 £ 136.00

£ **99.00**

Guide holder up to 6"

Guide holder 5–6"
Art. No. 563200 £ 154.00

£ **99.00**

REMS Aquila 3B

Mobile pipe machining station. Safe clamping of pipes up to 6". Everywhere on site.

Ø 10–165 mm, ¼–6"



REMS Aquila 3B

Pipe processing station with chain pipe vice for clamping pipes Ø 10–165 mm, Ø ¼–6". Work plate with integrated chain pipe vice with double clamping jaws, pipe rest, tool holders, 3 benders for bending pipes Ø 10–26 mm, Ø ¼–¾", clamping head. Folding tripod stand with shelf plate. In a carton.
Art. No. 120270 £ 318.00

£ **265.00**

REMS Aquila WB

Safe clamping of pipes up to 6".



Ø 10–165 mm, ¼–6"

German quality product

REMS Aquila WB

High quality chain pipe vice for clamping pipes Ø 10–165 mm, Ø ¼–6". Base plate with integrated chain pipe vice with double clamping jaws, pipe rest, bending device. For work bench. In a carton.
Art. No. 120250 £ 188.00

£ **165.00**

REMS CleanM – you can't get cleaner than that. Very high cleaning effect.



German quality product



REMS CleanM

Highly effective machine cleaner for fast and reliable removal of oily and greasy soiling 500 ml spray bottle.
Art. No. 140119

£ 18.20

REMS DueCento – Cutting up to Ø 225 mm.

Right angled. Chip-free. Ready for welding. Fast. Without outside burr. Dry. Universal for many pipe types.

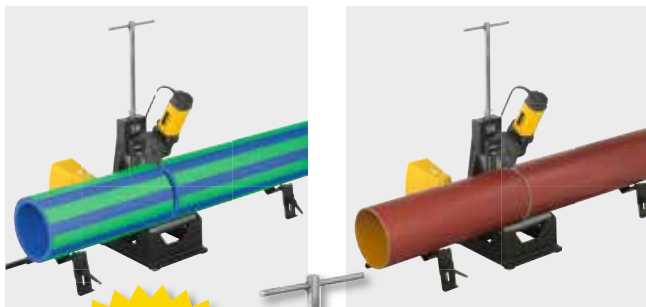

up to
Ø 225 mm



German quality product

FREE*

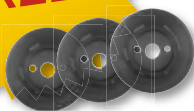

REMS DueCento Basic

Pipe cutting machine for fast, right angled cutting of pipes Ø 40–225 mm, without outside burr. For pipes of the press fitting systems made from stainless steel, carbon steel, copper, Ø 54–225 mm. For steel pipes EN 10255 (DIN 2440) DN 50–150, Ø 2–6", cast pipes (SML) EN 877 (DIN 19522) DN 50–200, plastic tubes SDR 11, wall thickness $s \leq 21$ mm, Ø 40–225 mm, composite tubes Ø 40–110 mm. With maintenance-free gears, proven universal motor 110 / 230 V, 50–60 Hz, 1,200 W. Speed 115 rpm. Hardened, precision tubular steel rollers for pipes Ø 100–225 mm, Ø 4–6". Safety foot switch. Ring spanner. Without cutter wheel. Two height adjustable pipe rests Ø 100–225 mm, Ø 4–6". In a carton.
Art. No. 845004 £ 1,820.00

Unique! Patent EP 1 782 904

Driven cutting wheel and straight in-feed for fast cutting

REMS cutter wheel Cu-INOX

for pipes of press fitting systems made of stainless steel, copper, carbon steel
Art. No. 845050

£ 65.90

REMS cutter wheel Cu

especially for pipes of the press fitting systems made of copper
Art. No. 845053

£ 65.90

REMS cutter wheel St

for steel pipes, cast pipes (SML)
Art. No. 845052

£ 65.90

REMS cutter wheel V, s 10

for plastic and multilayer composite tubes, wall thickness $s \leq 10$ mm
Art. No. 845051

£ 65.90

REMS cutter wheel P, s 21

for plastic and multilayer composite tubes, wall thickness $s \leq 21$ mm
Art. No. 845057

£ 83.40

REMS cutter wheel C-SF

especially for pipes of the press fitting systems/push fitting systems of carbon steel, simultaneously produces a chamfer.
Art. No. 845055

£ 65.90

Roller insert

for cutting pipes Ø 40–100 mm, Ø 1½–3½"
Art. No. 845060

£ 146.00

Pipe support Ø 40–100 mm

Height adjustable, for pipes Ø 40–100 mm, Ø 1½–3½"
Art. No. 845230

£ 93.30

Pipe support Ø 100–225 mm

Height adjustable for pipes Ø 100–225 mm, Ø 4–6"
Art. No. 845220

£ 93.30

Super offer!

You get 3 cutting wheels of your choice free when you buy a REMS DueCento Basic! An additional saving of between £ 197.70 and £ 250.20.

Art. No. 845X03 £ 1,849.00

**Ultra-fast,
e.g. INOX Ø 54 mm in only 4 seconds.**



1200 W
Only 17 kg

German
quality product



Stand

Herkules 3B

Herkules Y

Jumbo

Herkules 3B

Herkules 3B

Jumbo E

REMS Cento – Cutting and deburring up to Ø 115 mm.

Right-angled. Chipless. Without outer burr. Dry.

Unique! Patent EP 1 782 904

Driven cutting wheel and straight in-feed for fast cutting

REMS Cento Basic

Pipe cutting machine for fast, right angled cutting of pipes Ø 8–115 mm, without outer burr. For pipes of the press fitting systems made from stainless steel, carbon steel, copper, Ø 8–108 mm. For steel pipes EN 10255 (DIN 2440) DN 10–100, Ø ¼–4", cast iron pipes (SML) EN 877 (DIN 19522) DN 50–100, plastic tubes SDR 11, wall thickness $s \leq 10$ mm, Ø 10–110 mm, composite tubes Ø 10–110 mm. With maintenance-free gear, proven 110 V, 50–60 Hz, 1200 W universal motor. Speed 115 rpm. Rollers made of hardened precision steel for pipes Ø 22–115 mm, Ø ¼–4". Safety foot switch. Ring spanner. Without cutting wheel. For workbench or subframe. In a carton.

Art. No. 845001 £ 910.00



FREE*

REMS cutting wheel Cu-INOX free!

Value £ 65.90

Art. No. 845X02

£ 789.00

REMS cutting wheel Cu-INOX

for pipes of press fitting systems made of stainless steel, copper, carbon steel

Art. No. 845050

£ 65.90

REMS cutting wheel Cu

especially for pipes of the press fitting systems made of copper

Art. No. 845053

£ 65.90

REMS cutting wheel St

for steel pipes, cast pipes (SML)

Art. No. 845052

£ 65.90

REMS cutting wheel V, s 10

for plastic and multilayer composite tubes, wall thickness $s \leq 10$ mm

Art. No. 845051

£ 65.90

REMS cutting wheel C-SF

for cutting carbon steel pipes and simultaneously producing a welding chamfer

Art. No. 845055

£ 65.90

Accessory Pack 1

consisting of stand and REMS Herkules 3B

Art. No. 120X01 £ 335.00

£ 269.00

Accessory Pack 2

consisting of Jumbo, Herkules 3B and Herkules Y

Art. No. 120X02 £ 600.00

£ 445.00

Accessory Pack 3

consisting of Jumbo E and Herkules 3B

Art. No. 120X03 £ 384.00

£ 308.00

Inside pipe deburring device up to DN 100 – ideal for pipes of the pressfitting systems etc.

REMS REG 28–108

Inside pipe deburring device for pipes of Ø 28–108 mm, Ø ¼–4".

For electric drive by the REMS Cento pipe cutting machine.

Art. No. 113840 £ 200.00

£ 179.00

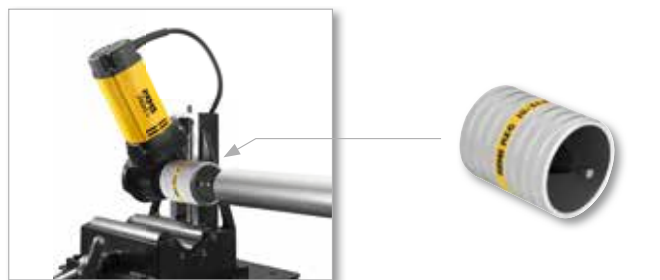

Protected by a German utility model registration!
Patent EP pending!

REMS REG 10–54 E – also for electric drive

Outer/inner pipe burr remover for pipes Ø 10–54 mm, ½–2½". Also for electric drive by REMS Helix (see page 24) and other power drills/screwdrivers (speed ≤ 300 rpm), by the pipe cutting machine REMS Cento (from date of manufacture 09/2011) or by the pipe circular sawing machine REMS Turbo Cu-INOX (from date of manufacture 09/2011).

Art. No. 113835 £ 83.40

£ 69.00



German quality product



Only 2.1 kg

REMS Akku-Nano – cutting up to Ø 40 mm.

Ultra-light. Fast. Right-angled. Chipless.
No outside burr. Dry.

Unique! Patent EP 2 077 175

Optimum engagement of the cutting wheel to the pipe to be cut.

REMS Akku-Nano Basic-Pack

Cordless pipe cutting machine for fast, right angled cutting of pipes Ø 10–40 mm, without outer burr. For pipes of the press fitting systems made of stainless steel, carbon steel, Ø 12–28 mm, copper Ø 10–35 mm. Multilayer composite tubes Ø 10–40 mm. With maintenance-free gear, powerful 10.8 V, 270 W battery motor. Speed 130 rpm. Safety switch. Li-Ion 10.8 V, 1.3 Ah battery, Li-Ion 110 V, 50–60 Hz rapid charger, 65 W. Back pressure rollers of hardened precision steel. Single open ended wrench size 8. Without cutting wheel. In carrying bag. Art. No. 844011 £ 455.00

£ **349.00**

REMS cutting wheel Cu-INOX

for pipes of press fitting systems made of:
stainless steel, carbon steel, copper

Art. No. 844050

£ **22.60**

REMS cutting wheel V

for multilayer composite tubes

Art. No. 844051

£ **22.60**

German quality product



Only 1.9 kg

REMS Nano – cutting up to Ø 40 mm.

Ultra-light. Fast. Right-angled. Chipless.
No outside burr. Dry.

Unique! Patent EP 2 077 175

Optimum engagement of the cutting wheel to the pipe to be cut.

REMS Nano Basic-Pack

Electric pipe cutting machine for fast, right angled cutting of pipes Ø 10–40 mm, without outer burr. For pipes of the press fitting systems made of stainless steel, carbon steel, Ø 12–28 mm, copper Ø 10–35 mm. Multilayer composite tubes Ø 10–40 mm. With maintenance-free gear, proven 110 V, 50–60 Hz, 130 W DC motor. Speed 130 rpm. Back pressure rollers made of hardened precision steel. Safety switch. Single open ended wrench size 8. Without cutting wheel. In carrying bag. Art. No. 844010 £ 327.00

£ **289.00**

REMS cutting wheel Cu-INOX

for pipes of press fitting systems made of:
stainless steel, carbon steel, copper

Art. No. 844050

£ **22.60**

REMS cutting wheel V

for multilayer composite tubes

Art. No. 844051

£ **22.60**

REMS REG – Robust quality tool for removing outer and inner burr from pipes.



For stainless steel pipes, other steel pipes,
copper, brass, aluminium and plastic pipes.

REMS REG 8–35

Outer/inner pipe burr remover for pipes Ø 8–35 mm, ¼–1¼".
Art. No. 113825 £ 39.70

£ **32.00**

REMS REG 10–54

Outer/inner pipe burr remover for pipes Ø 10–54 mm, ½–2¼".
Art. No. 113830 £ 45.50

£ **37.00**

Protected by a German utility model registration!

REMS REG 10–54 E – also for electric drive

Outer/inner pipe burr remover for pipes Ø 10–54 mm, ½–2¼". Also for electric drive by REMS Helix (see page 24) and other power drills/screwdrivers (speed ≤ 300 rpm), by the pipe cutting machine REMS Cento (from date of manufacture 09/2011) or by the pipe circular sawing machine REMS Turbo Cu-INOX (from date of manufacture 09/2011).
Art. No. 113835 £ 83.40

£ **69.00**



Rugged quality tools for tough use and long service life.

Rugged design in chrome-vanadium steel, all steel, drop forged, tempered, powder-coated. Hardened, highly wear resistant toothing.



REMS Catch S 1" + S 1½" + W 240

Swedish pattern wrench 'S'. DIN 5234 – Form C. Water pump pliers, 7 grip positions. DIN ISO 8976. Art. No. 116X01 £ 89.50

£ **52.00**

REMS Catch S 1" + S 1½" + S 2"

Swedish pattern wrench 'S'. DIN 5234 – Form C. Art. No. 116X02 £ 132.00

£ **75.00**

REMS Akku-ROS P 40 – fast, easy cutting of pipes. Powerful, e.g. Ø 20 mm multilayer composite tubes in only 4 s.

Up to 200 cut sections per battery charge!

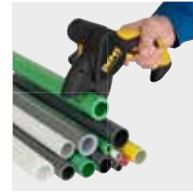

Only 1.2 kg!

Wedge-shaped blade for universal cutting of plastic and multilayer composite tubes

REMS Akku-ROS P 40 Set

Cordless pipe shears for fast, easy cutting of plastic and multilayer composite tubes Ø ≤ 40 mm, Ø ≤ 1½", s ≤ 6.7 mm. Electrical drive with powerful 9.6 V, 70 W battery motor, maintenance-free gear, safety switch, on/off switch. NiMH 9.6 V, 1.0 Ah battery, NiMH 100–240 V, 50–60 Hz, 6 W battery charger. With wedge-shaped blade. In a carton. Art. No. 291310 £ 103.00

£ **69.00**

REMS RAS P – highly resistant pipe cutter for cutting plastic and multilayer composite tubes.

Very stable spindle, long spindle guide and specially hardened back pressure rollers. Exact guiding on the pipe, easy engagement, easy cutting and accurate, right-angled cut as a result. Quick adjustment of the engagement spindle in both directions.

International Design Award



REMS RAS P 10–40

Pipe cutter for pipes Ø 10–40 mm, ½–1½". Art. No. 290050 £ 91.00

£ **69.00**

German quality product



REMS RAS P 50–110

Pipe cutter for pipes Ø 50–110 mm, 2–4". Art. No. 290100 £ 142.00

£ **115.00**

German quality product



REMS RAS P 10–63

Pipe cutter for pipes Ø 10–63 mm, ½–2". Art. No. 290000 £ 98.10

£ **79.00**



REMS RAS P 110–160

Pipe cutter for pipes Ø 110–160 mm, 4–6". Art. No. 290200 £ 175.00

£ **145.00**

REMS ROS P – handy pipe cutter for clean, fast cutting of plastic and multilayer composite tubes.



REMS ROS P 42

Pipe cutter with fast return for pipes Ø ≤ 42 mm, 1½". Art. No. 291250 £ 65.90

£ **55.00**



REMS ROS P 26

Fast cutting in one cut. Pipe shears for one-hand operation. For pipes Ø ≤ 26 mm, 1". Art. No. 291240 £ 35.20

£ **28.00**

For particularly easy cutting.



REMS ROS P 35

Pipe cutter with fast return for pipes Ø ≤ 35 mm, 1¾". Art. No. 291200 £ 37.60

£ **32.00**

REMS ROS P 42 PS

Pipe cutter with fast return for pipes Ø ≤ 42 mm, 1½". Art. No. 291000 £ 53.70

£ **49.00**

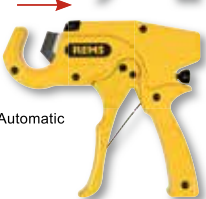

Automatic

REMS ROS P 35 A

Pipe cutter with automatic fast return for pipes Ø ≤ 35 mm, 1¾". Art. No. 291220 £ 47.10

£ **41.00**

REMS ROS P 63 P

Pipe cutter with fast return for pipes Ø ≤ 63 mm, 2". Art. No. 291270 £ 107.00

£ **83.00**

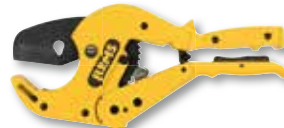

REMS RAS Cu-INOX S – highly resistant, needle bearing mounted pipe cutter for cutting pipes made from stainless steel, carbon steel, copper etc. For very easy cutting.



Counter pressure rollers on needle bearings.
Cutting wheel on needle bearing.



Quick adjustment of the engagement spindle in both directions (REMS RAS Cu-INOX 8–64 S).



New

REMS RAS Cu-INOX 3–28S Mini
On needle bearing. For pipes Ø 3–28 mm, ¼–1¼".
Art. No. 113241 £ 33.90

£ **29.00**



REMS RAS Cu-INOX 3–35S
On needle bearing with integrated pipe deburrer for pipes Ø 3–35 mm, ¼–1¾".
Art. No. 113351 £ 50.00

£ **35.00**



REMS RAS Cu-INOX 8–64S
On needle bearing with quick adjustment for pipes Ø 8–64 mm, ½–2½".
Art. No. 113401 £ 132.00

£ **105.00**

German quality product

REMS RAS Cu-INOX – highly resistant pipe cutter for cutting pipes made of stainless steel, carbon steel, copper etc.

Robust, sturdy structure for harsh conditions. Very stable spindle, long spindle guide and specially hardened back pressure rollers. Exact guiding on the pipe, easy engagement, easy cutting and accurate, right-angled cut as a result.

International Design Award



REMS RAS Cu-INOX 6–42
Pipe cutter for pipes Ø 6–42, ¼–1¾".
Art. No. 113380 £ 94.80

£ **85.00**

German quality product



REMS RAS Cu-INOX 3–35
Pipe cutter for pipes Ø 3–35 mm, ¼–1¾", with integrated pipe burr remover.
Art. No. 113350 £ 36.40

£ **29.00**



REMS RAS Cu-INOX 6–64
Pipe cutter for pipes Ø 6–64, ¼–2½".
Art. No. 113400 £ 113.00

£ **96.00**



REMS RAS Cu-INOX 3–42
Pipe cutter for pipes Ø 3–42 mm, ¼–1¾", with integrated pipe burr remover.
Art. No. 113330 £ 46.60

£ **35.00**

REMS RAS Cu – highly resistant pipe cutter especially for cutting copper pipes

Very stable spindle, long spindle guide and specially hardened back pressure rollers. Exact guiding on the pipe, easy engagement, easy cutting and accurate, right-angled cut as a result.

International Design Award

Quick adjustment of the engagement spindle in both directions.



REMS RAS Cu 8–42
Pipe cutter for pipes Ø 8–42, ½–1¾".
Art. No. 113370 £ 84.80

£ **73.00**

German quality product



REMS RAS Cu 3–35
Pipe cutter for pipes Ø 3–42 mm, ¼–1¾", with integrated pipe burr remover.
Art. No. 113340 £ 33.30

£ **28.00**



REMS RAS Cu 8–64
Pipe cutter for pipes Ø 8–64, ½–2½".
Art. No. 113410 £ 102.00

£ **83.00**



REMS RAS Cu 3–42
Pipe cutter for pipes Ø 3–42 mm, ¼–1¾", with integrated pipe burr remover.
Art. No. 113320 £ 42.40

£ **30.00**

One system – 4 applications!

Ideal for plumbers!



German
quality product

REMS Picus SR Set Titan

Electric diamond core drilling machine with speed regulation. For core drilling in concrete, steel-reinforced concrete up to Ø 162 (200) mm, masonry and others up to Ø 250 mm. For dry or wet drilling, hand held or with drill stand. Drive machine with drilling crown connection thread UNC 1¼ male, G ½ female, maintenance-free 2-step gear with safety slip clutch, 110 V, 50–60 Hz, 2200 W universal motor. Stepless electronic speed regulation 200 rpm to 500 rpm (1st gear) or 500 rpm to 1200 rpm (2nd gear), overheating protection. Multifunction electronics with soft starting, idle speed limiting, overload protection, blocking protection. Touch switch with lock. Personal protection switch (PRCD). Water supply device with adjustable shut-off valve and quick coupling with water stop and ½" hose connection. Stabiliser. Single open ended wrench size 32. In sturdy steel case. Drill stand REMS Titan including fastening kit for masonry and concrete. Without diamond core drilling crowns.

Art. No. 183022 £ 2,120.00

£ **1,649.00**

REMS Picus SR Set 62-82-132 Titan

Same as Art. No. 183022, but with REMS Universal diamond core drilling crowns UDKB Ø 62, 82, 132 mm.

Art. No. 183023 £ 2,660.00

£ **2,119.00**

... now with REMS Titan drill stand – for highest demands. For core drilling up to Ø 300 mm.

REMS Picus S2/3.5 – for core drillings in steel-reinforced concrete etc. up to Ø 300 mm.



REMS Picus S2/3,5 Set Titan

Electric diamond core drilling machine for core drilling in concrete, steel-reinforced concrete, masonry of all kinds, natural stone, asphalt, screeds of all kind, up to Ø 300 mm. For dry or wet drilling with drill stand. Drive machine with drilling crown male connection thread UNC 1¼, maintenance-free 2-step gear with safety slip clutch, 110 V, 50–60 Hz, 3420 W universal motor. Multifunction electronics with soft starting, idle speed limiting, overload protection, blocking protection. Rocker switch. Personal protection switch (PRCD). Load speed drilling spindle 320 rpm, 760 rpm. Water supply device with adjustable shutoff valve and quick coupling with water stop and ½" hose connection. Easy loosening ring. Single open-ended wrench size 32. Drill stand REMS Titan including fastening kit for masonry and concrete. Without diamond core drilling crowns.

Art. No. 180030 £ 3,320.00

£ **2,669.00**

REMS Picus S1 – the low cost alternative



... now with REMS Simplex 2 drill stand

Robust, handy drill stand for core drilling up to Ø 200 mm. Drill column made of rigid, unbendable square precision steel tube Ø 50 mm, cold solidified, with extra narrow tolerance, for low-vibration guiding of the slide

REMS Picus S1 Set Simplex 2

Electric diamond core drilling machine for core drilling in concrete, steel-reinforced concrete up to Ø 102 (132) mm, masonry and others up to Ø 162 mm. For dry or wet drilling, hand held or with drill stand. Drive unit with drilling crown male connection thread UNC 1¼, female connection thread G ½, maintenance-free gear with safety slip clutch, 110 V / 230 V, 50 – 60 Hz, 1850 W universal motor. Multifunction electronics with soft starting, idle speed limiting, overload protection, blocking protection. Touch switch with lock Personal protection switch (PRCD). Load speed drilling spindle 580 rpm. Water supply device with adjustable shutoff valve and quick coupling with water stop and ½" hose connection. Stabiliser. Drill start aid G ½ with Ø 8 mm drill, size 3 Allen key. Size 32 opened ended wrench. In sturdy steel case. REMS Simplex 2 drill stand including fastening set for masonry and concrete. Without diamond core drilling crowns.

Art. No. 180032 £ 1,760.00

£ **1,399.00**

The low price Starter Set. Ideal for pipework installers.



REMS UDKB Set 62-82-132

Ø 62, 82, 132 mm
Art. No. 181102 £ 570.00

REMS UDKB LS Set 62-82-132

Ø 62, 82, 132 mm
Art. No. 181112 £ 630.00

£ **371.00**

£ **410.00**

REMS Turbo Cu-INOX – burr-reduced, right angle, rapid.



REMS Turbo Cu-INOX Basic

Circular pipe saw with universal double clamping vice for burr-reduced, right angle, rapid sawing. Ideal for stainless steel and copper tubes of pressfitting systems. For REMS saw blade Ø 225 mm. With maintenance-free gear, proven universal motor 230 V or 110 V, 50 – 60 Hz, 500 W. Safety tip switch, saw blade protection cover. Speed 60 rpm. Ring spanner. Hexagon key. Without saw blade. For workbench and stand. In a carton.
Art. No. 849006 £ 820.00



+ gift package with a value £ 345.00*

1 REMS circular saw blade HSS-E (cobalt alloyed),
225 x 2 x 32, 220 teeth. Very long service life.
1 stand

Art. No. 849X01 £ **799.00**

REMS Universal diamond core drilling crowns

Inductively soldered on fully automatic soldering machines for constant high quality of the soldered connection. Drilling tubes with soldered diamond segments can be resoldered by simple hard soldering.

Universally usable for many materials, for dry and wet drilling, hand held or with drill stand. Uniform UNC 1/4 female connection thread. Drilling depth 420 mm. Diamond segments with wedge-shaped cut ("roof shape") for fast, easy and quiet drilling. Specially developed, high quality diamond segments with high diamond content and special bonding for excellent drilling performance and very long life. Ideal for universal use in steel-reinforced concrete and masonry.

Can be driven by all REMS Picus drive units and suitable drive units of other makes with a UNC 1/4 male connection thread.

**Inductively soldered!
Resolderable!**



- 35 %

German quality product



Ø x drilling depth x connection		Art. No.	£	Offer £
UDKB 32 x 420 x UNC 1/4	4	181010	96.50	63.00
UDKB 42 x 420 x UNC 1/4	4	181015	112.00	73.00
UDKB 52 x 420 x UNC 1/4	5	181020	117.00	76.00
UDKB 62 x 420 x UNC 1/4	6	181025	142.00	92.00
UDKB 72 x 420 x UNC 1/4	7	181030	155.00	101.00
UDKB 82 x 420 x UNC 1/4	7	181035	156.00	101.00
UDKB 92 x 420 x UNC 1/4	8	181040	169.00	110.00
UDKB 102 x 420 x UNC 1/4	8	181045	173.00	112.00
UDKB 112 x 420 x UNC 1/4	9	181050	196.00	127.00
UDKB 125 x 420 x UNC 1/4	10	181057	227.00	148.00
UDKB 132 x 420 x UNC 1/4	11	181060	252.00	164.00
UDKB 152 x 420 x UNC 1/4	12	181065	286.00	186.00
UDKB 162 x 420 x UNC 1/4	12	181070	307.00	200.00
UDKB 182 x 420 x UNC 1/4	12	181075	318.00	207.00
UDKB 200 x 420 x UNC 1/4	12	181080	326.00	212.00
UDKB 225 x 420 x UNC 1/4	13	181085	433.00	281.00
UDKB 250 x 420 x UNC 1/4	14	181090	487.00	317.00
UDKB 300 x 420 x UNC 1/4	22	181095	550.00	358.00

REMS universal diamond core drilling crowns LS (LASER)

Laser-welded on fully automatic welding machines for consistent high quality of the weld. High temperature-resistant, even under extreme temperature load, no desoldering of the segments due to overheating.

Universally usable for many materials, for dry and wet drilling, hand held or with drill stand. Uniform UNC 1/4 female connection thread. Drilling depth 420 mm. Diamond segments with wedge-shaped cut ("roof shape") for fast, easy and quiet drilling. Specially developed, high quality diamond segments with high diamond content and special bonding for excellent drilling performance and very long life. Ideal for universal use in steel-reinforced concrete and masonry.

Can be driven by all REMS Picus drive units and suitable drive units of other makes with a UNC 1/4 male connection thread.

**Laser-welded!
High temperature-resistant!**



- 35 %



Ø x drilling depth x connection		Art. No.	£	Offer £
UDKB LS 32 x 420 x UNC 1/4	1	181410	107.00	70.00
UDKB LS 42 x 420 x UNC 1/4	4	181415	124.00	81.00
UDKB LS 52 x 420 x UNC 1/4	5	181420	129.00	84.00
UDKB LS 62 x 420 x UNC 1/4	6	181425	157.00	102.00
UDKB LS 72 x 420 x UNC 1/4	6	181430	171.00	111.00
UDKB LS 82 x 420 x UNC 1/4	7	181435	172.00	112.00
UDKB LS 92 x 420 x UNC 1/4	8	181440	186.00	121.00
UDKB LS 102 x 420 x UNC 1/4	9	181445	191.00	124.00
UDKB LS 112 x 420 x UNC 1/4	9	181450	216.00	140.00
UDKB LS 125 x 420 x UNC 1/4	10	181457	250.00	163.00
UDKB LS 132 x 420 x UNC 1/4	10	181460	277.00	180.00
UDKB LS 152 x 420 x UNC 1/4	11	181465	315.00	205.00
UDKB LS 162 x 420 x UNC 1/4	12	181470	338.00	220.00
UDKB LS 182 x 420 x UNC 1/4	13	181475	350.00	228.00
UDKB LS 200 x 420 x UNC 1/4	14	181480	359.00	233.00

REMS Pull – for dry and wet suction.

Constantly high suction performance by permanent automatic filter cleaning. Certified for collecting health hazardous dusts in accordance with EN 60335-2-69¹⁾.

REMS Pull

Electric dry and wet industrial vacuum cleaner / dust extractor. For extraction of dusts, dirt and liquids. Ideal for dust extracting when chasing, cutting, drilling, core drilling and grinding. Bypass motor 230 V, 50–60 Hz, 1,200 W. On/Off switch and switch for automatic filter cleaning with integrated green LED. Suction power switch for continuous adjustment of the air volume flow ≤ 61 l/s. Filling level limit with automatic switch-off. Automatic filter cleaning. Appliance socket for power tools up to 2,200 W, with electronic automatic on/off. Large tank capacity 35 l, filling volume for liquids 19 l. Mobile, 2 wheels, steering roller/steering roller with brake. Connecting cable 7.5 m. 1 paper filter bag, 1 flat folded paper filter. 2 suction hoses 0.5 m, handle piece, suction hose 2.5 m, suction hose extension 2.5 m, handle, 2 metal suction pipes 0.5 m each. Attachment for surfaces wet/dry 300 mm with rollers, brush strips, rubber lips. Attachment for joints. Adapter suction hose/power tool. Integrated holders for connecting cable, suction hose and accessories. In a box.

REMS Pull L Set

Certified as an industrial vacuum cleaner and dust extractor for collecting health hazardous dusts of dust class L¹⁾. Exposure limit/work place limit > 1 mg/m³, penetration level ≤ 1 %.

Art. No. 185500 £ 474.00

£ **415.00**

REMS Pull L Set W

REMS Pull L Set W – ideal for the removal of drilling mud during wet drilling with REMS drill stands. REMS Pull L Set with water-resistant flat-folded paper filter PES and water suction device.

Art. No. 185503 £ 790.00

£ **689.00**

REMS Pull M Set

Certified as an industrial vacuum cleaner and dust extractor for collecting health hazardous dusts of dust class M¹⁾. Exposure limit/work place limit > 0.1 mg/m³, penetration level ≤ 0.1 %. With antistatic system. Electrically conductive suction hose E. Electronic volume flow monitor, selector switch suction hose diameter, plug for the suction hose connecting nozzle.

REMS Pull M with antistatic system: static charge is discharged via the earthed upper section of the vacuum cleaner by electrically conductive metal suction hoses, handle piece E, electrically conductive suction hose E, electrically conductive suction hose extension E and electrically conductive suction hose connecting nozzles.

Art. No. 185501 £ 640.00

£ **549.00**

REMS Pull M Set D

REMS Pull M Set D – ideal for the extraction of hazardous dust when dry drilling with REMS Picus S1, Picus SR, Picus S3, amongst others. REMS Pull M Set with suction rotor for dust extraction.

Art. No. 185504 £ 750.00

£ **679.00**



German quality product

*ambient/water temperature approx. 18°C.

REMS Frigo 2 – electrically freeze instead of emptying. Ultra-fast up to 2".

Unique! Patent EP 1 108 944

One-piece freezing heads for the main working range $\varnothing 1/4 - 1"$ or $\varnothing 15 - 35$ mm, no reducer inserts required. Very compact freezing heads with specially geometrically designed recesses for holding the respective different pipe diameters. Very narrow, only 50 mm wide. Can be used everywhere, even in narrow places. No pastes/greases required.

REMS Frigo 2 Set

Electrical pipe freezing device with closed coolant circuit. For steel, copper, plastic, multilayer composite pipes, $\varnothing 1/4 - 2"$, $\varnothing 10 - 60$ mm. Cooling unit 110 V, 50 Hz, 430 W, 2 coolant hoses, 2 clamping straps, 2 LCD digital thermometer, spray bottle. Equipment for $\varnothing 1/4 - 1 1/4"$, 15–42 mm. In sturdy steel housing.

Art. No. 131011 £ 1,090.00

£ **859.00**



Upgrade kit 1 1/2–2" / 54–60 mm

Art. No. 131160

£ **178.00**

Extraction of health hazardous dusts in accordance with EN 60335-2-69

When working with mineral building materials, e.g. concrete, steel-reinforced concrete, masonry and screed, a high degree of mineral dust containing quartz is produced which is harmful to the health. Inhalation of quartz fine dust is harmful to the health. EN 60335-2-69 prescribes the use of at least one safety extractor of dust class M¹⁾ for the extraction of health hazardous dusts with an exposure limit/work place limit of > 0.1 mg/m³. REMS Pull M, wet and dry industrial vacuum cleaner, certified for extracting hazardous dust of dust class M, see left.

REMS Krokodil – chasing instead of chiselling.



German quality product



REMS Krokodil 180 SR Basic-Pack

Electric diamond chasing and cutting grinder with speed regulation. For chasing and cutting, e.g. concrete, steel-reinforced concrete, masonry of all kinds, natural stone, screeds of all kinds. Chase depth ≤ 62 mm, continuously adjustable. Chasing width ≤ 61 mm, stepped with spacer discs 3, 6, 10, 20 mm. Drive machine with drive shaft Ø 22.2 mm, for 1, 2 or 3 diamond cutting discs in accordance with EN 13236, Ø ≤ 180 mm, with maintenance-free gear, 110 V, 50–60 Hz, 2,000W universal motor. Multifunction electronics with soft start, idling speed limiting, overload protection, overheating protection. Restart protection in case of mains failure. Safety switch with lock. Load speed 5,000 rpm. Suction nozzle for connecting a vacuum cleaner/dust extractor (e.g. REMS Pull M). Pin wrench size 13. In sturdy steel case.

Art. No. 185011 £ 820.00

+ gift package with a value £ 80.00*

2 REMS universal diamond cutting disc LS-Turbo Ø 180 mm

REMS Krokodil 125 Basic-Pack

Electric diamond chasing and cutting grinder for chasing and cutting, e.g. concrete, steel-reinforced concrete, masonry of all kinds, natural stone, screeds of all kinds. Chase depth ≤ 38 mm, continuously adjustable. Chasing width ≤ 43 mm, stepped with spacer discs 3, 6, 10, 20 mm. Drive machine with drive shaft Ø 22.2 mm, for 1 or 2 diamond cutting discs in accordance with EN 13236, Ø ≤ 125 mm, with maintenance-free gear with safety slip clutch, 110 V, 50–60 Hz, 1,850 W universal motor. Multifunction electronics with soft start, idling speed limiting, overload protection. Safety switch with lock. Load speed 5,000 rpm. Suction nozzle for connecting a vacuum cleaner/dust extractor (e.g. REMS Pull M). Pin wrench size 13. In sturdy steel case.

Art. No. 185010 £ 690.00

+ gift package with a value £ 45.40*

2 REMS universal diamond cutting disc LS-Turbo Ø 125 mm



Art. No. 185X03 £ **779.00**



Art. No. 185X02 £ **499.00**

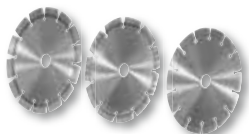

REMS universal diamond cutting disc Eco Ø 180 mm

Sintered, with metal body in accordance with EN 13236
Art. No. 185025

£ **17.20**

REMS universal diamond cutting disc LS-Turbo Ø 180 mm

Laser-welded, high temperature-resistant, for fast cuts and cuts in hard materials, with metal body in accordance with EN 13236
Art. No. 185026

£ **40.00**

REMS universal diamond cutting disc LS H-P Ø 180 mm

High-performance, laser-welded, high temperature-resistant, for fast cuts and cuts in very hard materials, long life, with metal body in accordance with EN 13236.
Art. No. 185027

£ **77.30**

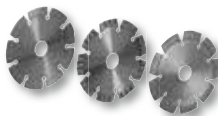

REMS universal diamond cutting disc Eco Ø 125 mm

Sintered, high temperature-resistant, with metal body in accordance with EN 13236
Art. No. 185020

£ **7.20**

REMS universal diamond cutting disc LS-Turbo Ø 125 mm

Laser-welded, high temperature-resistant, for fast cuts and cuts in hard materials, with metal body in accordance with EN 13236
Art. No. 185021

£ **22.70**

REMS universal diamond cutting disc LS H-P Ø 125 mm

High-performance, laser-welded, high temperature-resistant, for fast cuts and cuts in very hard materials, long life, with metal body in accordance with EN 13236.
Art. No. 185022

£ **45.50**

¹⁾ Observe the national regulations for the collection and disposal of health hazardous dusts.

REMS CamScope / REMS CamScope S – Brilliant pictures and videos of cavities, shafts and pipes. Documentation on MicroSD card.



REMS CamScope Li-Ion

Mobile, handy endoscope camera with radio signal transmission for low cost inspection and damage analysis of places with difficult access such as cavities, shafts, pipes etc. Documentation of photos and videos on MicroSD card. Handheld unit with 4 batteries 1.5 V, AA, LR6 Removable controller unit with radio signal transmission, 3.5" TFT-LCD colour display, MicroSD card slot, USB port, video out socket PAL/NTSC, integrated Li-ion battery, 3.7 V, 1.2 Ah. 2 GB MicroSD card Voltage supply/charger Li-Ion 100–240 V, 50 – 60Hz, 9 W, for controller unit. USB cable, video cable In sturdy case Optional with camera cable set 4.5-1, camera cable set 9-1 or camera cable set 16-1.



REMS CamScope S Li-Ion – with voice recording.

Mobile, handy endoscope camera with radio signal transmission for low cost inspection and damage analysis of places with difficult access such as cavities, shafts, pipes etc. Documentation of photos and videos with voice recording on MicroSD card. Handheld unit with 4 batteries 1.5 V, AA, LR6 Removable controller unit with radio signal transmission, 3.5" TFT-LCD colour display, 3x digital zoom, MicroSD card slot, USB port, video out socket PAL/NTSC, integrated Li-ion battery, 3.7 V, 1.2 Ah. 2 GB MicroSD card Voltage supply/charger Li-Ion 100–240 V, 50 – 60Hz, 9 W, for controller unit. USB cable, video cable In sturdy case Optional with camera cable set 4.5-1, camera cable set 9-1 or camera cable set 16-1.

REMS CamScope Li-Ion Set 16-1

Camera cable set Color 16-1, consisting of colour camera Ø 16 mm, 704×576 pixels, with dimmable white light LEDs and fixed focus function and 1 m formable push cable. Add-on mirror, add-on hook, add-on magnet. Art. No. 175110 £ 313.00

£ **275.00**

REMS CamScope S Li-Ion Set 16-1

Camera cable set Color 16-1, consisting of colour camera Ø 16 mm, 704×576 pixels, with dimmable white light LEDs and fixed focus function and 1 m formable push cable. Add-on mirror, add-on hook, add-on magnet. Art. No. 175130 £ 389.00

£ **319.00**

REMS CamScope Li-Ion Set 9-1

Camera cable set Color 9-1, consisting of colour camera Ø 9 mm, 640×480 pixels, with dimmable white light LEDs and fixed focus function and 1 m formable push cable. Add-on mirror, add-on hook, add-on magnet. Art. No. 175111 £ 319.00

£ **285.00**

REMS CamScope S Li-Ion Set 9-1

Camera cable set Color 9-1, consisting of colour camera Ø 9 mm, 640×480 pixels, with dimmable white light LEDs and fixed focus function and 1 m formable push cable. Add-on mirror, add-on hook, add-on magnet. Art. No. 175131 £ 395.00

£ **339.00**

REMS CamScope Li-Ion Set 4,5-1

Camera cable set Color 4.5-1, consisting of colour camera Ø 4.5 mm, 320×240 pixels, with dimmable white light LEDs and fixed focus function and 1 m formable push cable. Ideal for inspecting small pipe bends and narrow places. Art. No. 175112 £ 366.00

£ **319.00**

REMS CamScope S Li-Ion Set 4,5-1

Camera cable set Color 4.5-1, consisting of colour camera Ø 4.5 mm, 320×240 pixels, with dimmable white light LEDs and fixed focus function and 1 m formable push cable. Ideal for inspecting small pipe bends and narrow places. Art. No. 175132 £ 443.00

£ **379.00**



900 mm push cable extension

couplable up to a working length of 4.5 m
Art. No. 175105

£ **32.40**

Camera cable set Color 16-1 90°

90° angled colour camera Ø 16 mm, 640×480 pixels, with 1 m flexible push cable.

Art. No. 175106

£ **122.00**

REMS CamScope Wi-Fi – Brilliant pictures and videos of cavities, shafts and pipes.

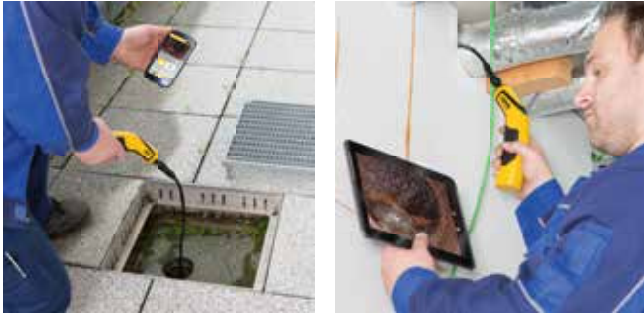

Wireless transmission of photos and videos to Smartphones/ tablet PCs with Android and iOS operating systems.



REMS CamScope Wi-Fi – with voice recording.

Mobile, handy endoscope camera with Wi-Fi radio standard for low cost inspection and damage analysis of places with difficult access such as cavities, shafts, pipes etc. Wireless transmission of photos and videos with voice recording to Smartphones/tablet PCs with Android or iOS* operating systems. Controller unit with 4 batteries 1.5 V, AA, LR6. In sturdy case Optional with camera cable set 4.5-1, camera cable set 9-1 or camera cable set 16-1.

REMS CamScope Wi-Fi Set 16-1

Camera cable set Color 16-1, consisting of colour camera Ø 16 mm, 704 × 576 pixels, with dimmable white light LEDs and fixed focus function and 1 m formable push cable.

Add-on mirror, add-on hook, add-on magnet.

Art. No. 175140 £ 212.00

£ **195.00**

REMS CamScope Wi-Fi Set 9-1

Camera cable set Color 9-1, consisting of colour camera Ø 9 mm, 640 × 480 pixels, with dimmable white light LEDs and fixed focus function and 1 m formable push cable.

Add-on mirror, add-on hook, add-on magnet.

Art. No. 175141 £ 219.00

£ **205.00**

REMS CamScope Wi-Fi Set 4,5-1

Camera cable set Color 4.5-1, consisting of colour camera Ø 4.5 mm, 320 × 240 pixels, with dimmable white light LEDs and fixed focus function and 1 m formable push cable. Ideal for inspecting small pipe bends and narrow places.

Art. No. 175142 £ 266.00

£ **235.00**



REMS CamScope App

*Free application software from the Apple App Store or Android App at Google Play.



REMS CamSys – electronic camera inspection system for low-cost inspection and damage analysis.



REMS CamSys Li-Ion Set S-Color

Electronic camera inspection system for low-cost inspection and damage analysis. Documentation of pictures and videos on SD card with specification of date, time and insertion depth of the camera. Controller unit in microprocessor technology with 3.5" TFT-LCD colour display, SD card slot, USB port, video out socket PAL/NTSC, integrated Li-ion battery, 3.7 V, 2.5 Ah, in sturdy, impact-proof plastic housing, spray protected. 2 m connecting cable from the controller unit to the camera cable set, voltage supply/charger 100–240 V, 50–60 Hz, 10 W, SD card 4 GB, USB cable, video cable, in sturdy case. Camera cable set S-Color with high resolution special colour camera Ø 25 mm with CMOS image sensor and push cable.

REMS CamSys Li-Ion Set S-Color 10 K

10 m push cable Ø 4.5 mm with length mark, very flexible, in cable reel. For small pipe diameters and narrow pipe bends Ø (40) 50–150 mm, drains, shafts, stacks and other cavities. Art. No. 175008 £ 1,470.00

£ **1,275.00**



REMS CamSys Li-Ion Set S-Color 20 H

20 m push cable Ø 4.5 mm, very flexible, in hasp with electronic metre counter. For small pipe diameters and narrow pipe bends Ø (40) 50–150 mm, drains, shafts, stacks and other cavities. Art. No. 175007 £ 1,870.00

£ **1,690.00**



REMS CamSys Li-Ion Set S-Color 30 H

30 m push cable Ø 5.4 mm, flexible, in hasp with electronic metre counter. For pipes Ø 50–150 mm, drains, shafts, stacks and other cavities. Art. No. 175010 £ 1,930.00

£ **1,749.00**

REMS TECHNOLOGY LI-ION PLUS



- Li-Ion 14.4 V battery with 1.6 or 3.2 Ah capacity for long service life.
- For over 300 pressing operations per battery charge on DN 15²⁾.
- Withstands very high stress.
- Low weight.
- Extended operating temperature range – 10 to +60 °C.
- Total discharge and overload protection with single cell monitoring.
- Temperature monitoring during the charging process.
- Short charging times.

REMS Mini-Press ACC – The real one-hand radial press!
Only 2.4 kg! Universal up to Ø 40 mm. Ultra-light.
Ultra-small. Ultra-handy. Ultra-fast. 360° rotatable.



Extremely "mini"
 < 33 cm (V 22)

Drive unit with pressing tongs V 22 only 33 cm long. Therefore usable universally, free hand, overhead, even in very confined spaces.

Very compact design and low weight of the REMS Mini pressing tongs due to special arrangement of the pressing tongs connection (Patent EP 1 952 948).

Extended pressing range up to 40 mm!



36
 MONTHS
 WARRANTY!

Charging status indicator



←ACC→

Automatic Circuit Control
 with automatic retraction

German quality product

LED work light



REMS Mini-Press ACC Li-Ion Basic-Pack

Cordless radial press with automatic return after completed pressing cycle (forced process), for producing press connections Ø 10–40 mm, Ø 3/8–1/4". For driving REMS Mini pressing tongs Rotating pressing tongs seat with automatic locking. Electro-hydraulic drive with powerful 14.4 V, 420 W battery motor, robust planetary gear, eccentric reciprocating pump and compact high power hydraulic system, safety switch. Integrated LED work light. Li-Ion 14.4 V, 1.6 Ah battery, Li-Ion/Ni-Cd 110 V / 230 V, 50–60 Hz, 65 W rapid charger. In sturdy steel case.
 Art. No. 578012 £ 980.00



+ gift package with a value of £ 136.30
 1 REMS cordless LED lamp Li-Ion;
 extra battery Li-Ion 14.4 V, 1.6 Ah
 Value £ 1,116.30

Art. No. 578X02 £ **859.00**



←ACC→

Automatic Circuit Control
with automatic retraction

German quality product

REMS TECHNOLOGY
LI-ION PLUS

LED



only 4.3 kg

LED work light

36 MONTHS WARRANTY!¹⁾

Charging status indicator



Universal up to Ø 110 mm. Compact.
Handy. Ultra-fast. 360° rotatable.

REMS Akku-Press Li-Ion Basic-Pack

Cordless radial press with switch-off signal after completed pressing cycle, for producing press connections Ø 10–108 (110) mm, Ø ¼–4". Li-Ion 14.4 V, 3.2 Ah battery, Li-Ion/Ni-Cd 110 V, 50–60 Hz, 65 W rapid charger. In sturdy steel case.

Art. No. 571013 £ 980.00

Art. No. 571X01 £ **929.00**

REMS Akku-Press ACC Li-Ion Basic-Pack

Cordless radial press with automatic return after completed pressing cycle (forced process), for producing press connections Ø 10–108 (110) mm, Ø ¼–4". See above for rest of delivery scope.

Art. No. 571014 £ 1,120.00

Art. No. 571X02 £ **979.00**



+ Gift package with every Basic-Pack:
1 cordless LED lamp Li-Ion
extra Li-Ion 14.4 V, 3.2 Ah battery
Value £ 172.30

←ACC→

Automatic Circuit Control
with automatic retraction

German quality product



only 4.7 kg

36 MONTHS WARRANTY!¹⁾

LED

Universal up to Ø 110 mm. Compact.
Handy. Ultra-fast. 360° rotatable.

REMS Power-Press Basic-Pack

Electro-hydraulic radial press with switch-off signal after completed pressing cycle, for producing press connections Ø 10–108 (110) mm, Ø ¼–4". For driving REMS pressing tongs/pressing rings and other suitable makes of pressing tongs/pressing rings. Rotating pressing tongs seat with automatic locking. Electro-hydraulic drive with proven 110 V, 50–60 Hz, 450 W universal motor, robust planetary gear, eccentric reciprocating pump and compact high performance hydraulic system, safety switch. In sturdy steel case.

Art. No. 577011 £ 850.00

£ **829.00**

REMS Power-Press ACC Basic-Pack

Electro-hydraulic radial press with automatic return after completed pressing cycle (forced process), for producing press connections Ø 10–108 (110) mm, Ø ¼–4". See above for rest of delivery scope.

Art. No. 577010 £ 940.00

£ **849.00**



36 MONTHS WARRANTY!¹⁾

German quality product

only 4.7 kg

REMS Power-Press SE – universal up to Ø 110 mm. Reliable pressing in seconds.

REMS Power-Press SE Basic-Pack

Electric radial press for production of press connections Ø 10–108 (110) mm, Ø ¼–4". For driving REMS pressing tongs/pressing rings and other suitable other makes of pressing tongs/pressing rings. Pressing tongs seat with automatic locking. Electro-mechanical drive with proven universal motor 110 / 230 V, 50–60 Hz, 450 W, maintenance-free gear with safety slipping clutch and in-feed system with machine screw spindle. Overload protection, safety switch. In sturdy steel case.

Art. No. 572111 £ 660.00

£ **619.00**



¹⁾Prolongation of the Manufacturer's Warranty of the drive unit to 36 months by annual inspection at an authorised REMS service depot. No registration necessary.

Details: www.rems.de → Downloads → Operating instructions → Select the operating instructions of the relevant drive unit → see "Prolongation of the Manufacturer's Warranty to 36 months".



German quality product

REMS pressing rings for large dimensions. Fit. Press. Finished.

REMS pressing rings (PR-3S) with 3 swivellable pressing formers mounted on a jointed ring for large dimension complex pressings. Optimum pressing by radially controlled movement of the pressing formers. Pressing contour M for Geberit Mapress and other suitable systems.

REMS pressing ring M42 (PR-3S)	Art. No. 572706	£ 446.00
REMS pressing ring M54 (PR-3S)	Art. No. 572708	£ 446.00
Intermediate tongs Z2 for driving REMS pressing rings (PR-3S) 42–54 mm	Art. No. 572795	£ 91.00
Steel case	Art. No. 572810	£ 61.90
Pressing ring set complete	Art. No. 572060	£ 1,050.00

£ **959.00**

REMS pressing tongs – Proven a million times over. For all common press fitting systems.

Unique!

Patent EP 1 223 008

All the REMS pressing tongs marked by * in the catalogue have another connection and also fit the REMS Eco-Press manual radial press. Thus simple, inexpensive stocking.



German quality product

Highly resistant pressing tongs made of forged and specially hardened steel. The pressing contours of the REMS pressing tongs are system-specific and correspond to the pressing contours of the respective press fitting systems. Perfect system-conformant, reliable pressing as a result. Pressing jaws of the pressing tongs with high-precision cut and exactly rounded pressing contour on CNC machining centres. Much lower production tolerances than only cast pressing contour as a result.

Traceability according to EN 1775:2007

REMS pressing tongs/pressing rings with pressing contour M, V, SA, B, HR and UP have worked a specific marking into the pressing contour which leaves a lasting impression on the pressed fitting after the pressing process. This enables the user to check again whether the most suitable pressing tongs or the suitable pressing ring have been used to make the pressfit connection even after the pressing process.

REMS pressing tongs / pressing tongs Mini M, V up to 35 mm

£ **85.00**

Other REMS pressing tongs / pressing tongs Mini up to 35 mm

£ **91.00**

e.g. F, G, RN, TH, U, UP, VP, VRX

With this traceability REMS fulfils the recommendations of the European standard EN 1775:2007 for the installation of pressfitting systems for gas.

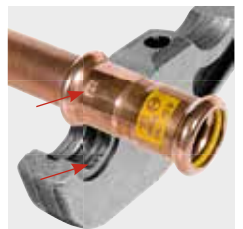

Example REMS pressing tongs M: Impression "M" on pressed fitting for traceability according to EN 1775:2007

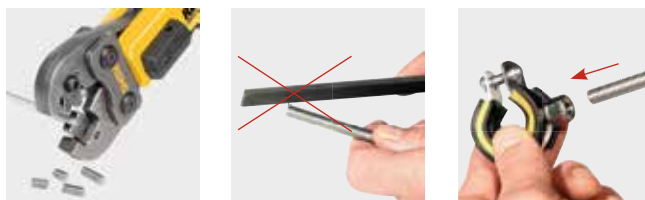

Cropping tongs with 1 pair of reversible cutting inserts for steel, stainless steel, M 6–M 12, up to strength class 4.8 (400 N/mm²).



German quality product

REMS cropping tongs M – cutting threaded bars. Ultra-fast.

Unique! – Patent EP 1 223 008

All cropping tongs marked by * have another connection for manual drive by the manual radial press REMS Eco-Press. Thus simple, inexpensive stocking.

For REMS Mini-Press ACC:

REMS Mini cropping tongs – cuts in just 2 seconds!

M 6	Art. No. 578620	
M 8	Art. No. 578621	
M 10	Art. No. 578622	instead of £ 146.00 now only

For REMS radial presses (except REMS Mini-Press ACC) and suitable radial presses of other makes:

REMS cropping tongs

M 6*	Art. No. 571890	
M 8*	Art. No. 571895	
M 10	Art. No. 571865	
M 12	Art. No. 571870	instead of £ 146.00 now only

£ **129.00**

REMS pressing rings 64–108 mm for Viega systems

REMS pressing rings (PR-3B) with 3 pressing jaws for high quality, large dimension pressings. Optimum pressing by radially controlled movement of the pressing jaws. Adapter tongs are necessary for driving the pressing rings. Drive by all REMS radial presses (except REMS Mini-Press ACC) and suitable radial presses of other makes.

REMS pressing rings (PR-3B)

System	Pressing contour	Art.-No.	£
Viega Copatin	VR 76,1 (PR-3B)	572822	401.00
	VR 88,9 (PR-3B)	572823	419.00
	VR 108,0 (PR-3B)	572824	419.00
Viega Prestabo	VF 64,0 (PR-3B)	572815	401.00
	VF 76,1 (PR-3B)	572816	401.00
	VF 88,9 (PR-3B)	572817	419.00
	VF 108,0 (PR-3B)	572818	419.00
Viega Profipress	VF 64,0 (PR-3B)	572815	401.00
Viega Profipress G	VF 64,0 (PR-3B)	572815	401.00

System	Pressing contour	Art.-No.	£
Viega Sanpress	VR 76,1 (PR-3B)	572822	401.00
	VR 88,9 (PR-3B)	572823	419.00
	VR 108,0 (PR-3B)	572824	419.00
Viega Sanpress Inox	VF 76,1 (PR-3B)	572816	401.00
Viega Sanpress Inox G	VF 64,0 (PR-3B)	572815	401.00
	VF 76,1 (PR-3B)	572816	401.00
	VF 88,9 (PR-3B)	572817	419.00
	VF 108,0 (PR-3B)	572818	419.00



Adapter tongs Z5

for driving the REMS pressing rings (PR-3B) VF/VR 64 – 108 mm
Art.-No. 572802

£ 228.00

REMS pressing rings 45° (PR-2B) – the problem solution for places with difficult access.

e.g. opened walls, exposed pipes, shafts



German quality product



REMS pressing ring V 12 45° (PR-2B)

Art. No. 574502

£ 54.60

REMS pressing ring V 15 45° (PR-2B)

Art. No. 574504

£ 59.20

REMS pressing ring V 18 45° (PR-2B)

Art. No. 574506

£ 63.70

REMS pressing ring V 22 45° (PR-2B)

Art. No. 574508

£ 68.30

REMS pressing ring V 28 45° (PR-2B)

Art. No. 574510

£ 72.80

REMS pressing ring V 35 45° (PR-2B)

Art. No. 574512

£ 77.40

REMS pressing ring M 12 45° (PR-2B)

Art. No. 574520

£ 54.60

REMS pressing ring M 15 45° (PR-2B)

Art. No. 574522

£ 59.20

REMS pressing ring M 18 45° (PR-2B)

Art. No. 574524

£ 63.70

REMS pressing ring M 22 45° (PR-2B)

Art. No. 574526

£ 68.30

REMS pressing ring M 28 45° (PR-2B)

Art. No. 574528

£ 72.80

REMS pressing ring M 35 45° (PR-2B)

Art. No. 574530

£ 77.40

REMS Mini adapter tong Z1

for driving REMS pressing rings 45° (PR-2B).

Suitable for REMS Mini-Press ACC.

Art. No. 578558

£ 91.00

REMS adapter tong Z1

for driving REMS pressing rings 45° (PR-2B). Suitable for all REMS radial

presses (except REMS Mini-Press ACC, REMS Power-Press XL ACC).

Art. No. 574500

£ 91.00

Steel case

with insert (for adapter tong Mini Z1 and adapter tong Z1 and 6 REMS

pressing rings V 12 – 35 45° (PR-2B) or M 12 – 35 45° (PR-2B)

Art. No. 574516

£ 61.90

REMS Helix VE – drilling, screw driving and deburring.



LED work light

REMS TECHNOLOGY
Li-ION PLUS

only 1.3 kg



FREE*

REMS Helix VE Li-Ion Set

Cordless power drill/screwdriver with Vario-Electronics (VE) for drilling in steel, stone, $\varnothing \leq 10$ mm, wood $\varnothing \leq 28$ mm and other materials and for screwing in/loosening screws $\varnothing \leq 7$ mm. Drive machine with keyless quick chuck, clamping range 0.8–10 mm, right and left hand rotation. Electromechanical drive with powerful battery motor 14.4 V, 300 W, 2-step robust planetary gear. 2 continuously ad-justable speed ranges from 0 to 300 rpm and 0 to 1,250 rpm, 25 torque stages plus drilling stage, high torque of 31 Nm in the low speed range. Safety switch. Integrated LED work light. Belt clip. Li-Ion 14.4 V, 1.6 Ah battery, Li-Ion/Ni-Cd 230 V, 50–60 Hz, 65 W rapid charger. 1 bit with double blade slot/cross-head, 50 mm long. In carrying bag.
Art. No. 190010 £ 309.00

+ gift package with a value of £ 181.30

1 set of bits free

A second 14.4 V, 3.2 Ah Li-Ion battery free

1 bodywarmer

Art. No. 190X02 £ **289.00**

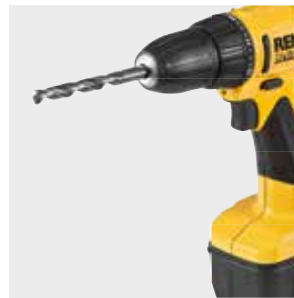

REMS tile drilling Set 6-8-10

Diamond-tipped dry drilling crowns with special wax filling. For ceramics, fine clay, granite, marble and other materials. 3 tile drill bits \varnothing 6, 8, 10 mm, drilling aid with vacuum attachment. For electric drive by power drill/screwdriver.
Art. No. 181700 £ 141.00



£ **99.00**



REMS REG 10–54 E

Outside/inside pipe deburrer for pipes \varnothing 10–54 mm, \varnothing $\frac{1}{2}$ –2 $\frac{1}{8}$ ". For electric drive by power drill/screwdriver.
Art. No. 113835 £ 83.40

£ **69.00**



Driver for REMS REG 10–42

for electric drive by power drill/screwdriver.
Art. No. 113815

£ **30.90**



REMS REG 10–42

Outside/inside pipe deburrer for pipes \varnothing 10–42 mm, \varnothing $\frac{1}{2}$ –1 $\frac{1}{8}$ ".
Art. No. 113810

£ **72.80**



German quality product



W 1.303



DW-0201AS2032



7808-649

Can be washed out with water, tested by experts.

REMS Spezial – high alloy thread cutting oil

High alloy mineral oil-based thread cutting oil. Developed especially for cutting threads. Very high lubricating and cooling effect. Absolutely essential for clean threads and long life of dies, tools and machines.

Spray 600 ml

Art. No. 140105

£ 14.20

£ **10.40**

Canister 5 l

Art. No. 140100

£ 43.00

£ **31.00**

Completely soluble in water. For drinking water pipes etc. According to DVGW, ÖVGW, SVGW regulations.

REMS Sanitol – mineral oil-free thread cutting oil

Synthetic, mineral oil-free thread cutting oil. Dyed red for checking washout. Excellent corrosion protection. Water-free. Developed especially for drinking water pipes, but also excellently suitable for universal thread cutting. Very high lubricating and cooling effect. Absolutely essential for clean threads and long life of dies, tools and machines.

Spray 600 ml

Art. No. 140115

£ 15.30

£ **12.50**

Canister 5 l

Art. No. 140110

£ 58.50

£ **43.00**

REMS Collum RG – Electric roll groover up to 12".

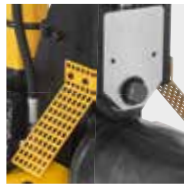

REMS Herkules 3B
(Accessory)

Wheel stand
(Accessory)

German quality product

REMS Collum RG

Roll grooving machine for grooving pipes for pipe coupling systems DN 25–300, 1–12". Roll grooving attachment, manual hydraulic pump, integrated, graduated ring gauge for automatic groove depth stop, 1 pair of grooving rollers (pressure roller, counterpressure roller) 2–6", Allen key. Choice of 3 drive units, with maintenance-free gear, powerful universal motor, safety switch. For workbench or subframe. In a carton.

REMS Collum RG

Universal motor 230 V, 50–60 Hz, 1200 W, overload protection. 29 min⁻¹.
Art. No. 347006 £ 1,880.00

£ 1,749.⁰⁰

REMS Collum RG 2

Universal motor 230 V, 50–60 Hz, 1700 W. 28 min⁻¹.
Art. No. 347008 £ 2,150.00

£ 1,949.⁰⁰

REMS Collum RG 2 Compact

Universal motor 230 V, 50–60 Hz, 1200 W, overload protection. 26 min⁻¹.
Art. No. 347009 £ 2,150.00

£ 1,949.⁰⁰

Stand

Art. No. 849315 £ 132.⁰⁰

Wheel stand

Art. No. 849310 £ 207.⁰⁰

REMS Herkules RG 6

Material support, height adjustable, for pipes DN 25–150, Ø 1–6"

Art. No. 120120 £ 203.⁰⁰

REMS eva – the die stock for professionals.

Very easy starting and thread cutting by precision processing of the die head, dies and cover in a compact unit. Ratchet lever of steel, thick plastic jacket.



German quality product

REMS Eva Set R 1/2-3/4-1-1 1/4

Manual die stock with quick-change die heads. For pipe threads 1/2–2", 16–50 mm, bolt threads 6–30 mm, 1/4–1". For right and left-hand threads. 1 ratchet lever for the entire cutting range. Quick-change die heads R 1/2-3/4-1-1 1/4 with dies for conical pipe threads ISO 7-1, EN 10226 (DIN 2999, BSPT) R right-hand. In sturdy steel case.
Art. No. 520015 £ 291.00

£ 269.⁰⁰

REMS Eva Set R 1/2-3/4-1-1 1/4-1 1/2-2

Manual die stock with quick-change die heads R 1/2-3/4-1-1 1/4-1 1/2-2. In sturdy steel case.
Art. No. 520017 £ 451.00

£ 359.⁰⁰



REMS Amigo E – the lightest, strongest and fastest up to 1".



950 W
only 3.4 kg



German quality product



REMS Amigo E Set M 20-25-32

Electric die stock with quick-change die heads. For pipe threads 1/4–1", 16–32 mm, for right and left-hand threads. Drive machine with maintenance-free gear, powerful 110 V, 50–60 Hz, 950 W universal motor, safety switch, power boosting automatic carbon brush adjustment in the direction of rotation selection. Peak consumption up to 1500 W. Right and left-hand rotation. Support bracket for both directions of rotation. REMS eva quick-change die heads for threads for electrical installation pipes DIN EN 60423 M. In sturdy steel case.
Art. No. 530014 £ 580.00

£ 379.⁰⁰

REMS Amigo – The smallest, lightest, strongest and fastest up to 1¼".



1200 W
Only 3.5 kg

German quality product



REMS Amigo Set M 16-20-25-32

Electric die stock with quick-change die heads. For pipe threads ¼–1¼", 16–40 mm, bolt threads 6–30 mm, ¼–1". For right and left-hand threads. Drive machine with maintenance-free gear, powerful universal motor 110 V, 50–60 Hz, 1200 W, safety switch, power boosting automatic carbon brush adjustment in the direction of rotation selection. Peak consumption up to 1800 W. Right and left-hand rotation, overload protection. Support bracket for both directions of rotation. REMS eva quick-change die heads for threads for electrical installation pipes DIN EN 60423 M. In sturdy steel case.
Art. No. 530022 £ 710.00

£ **499.00**

REMS Amigo 2 – extremely strong up to 2".



1700 W
Only 6.5 kg

German quality product



REMS Amigo 2 Set R ½-¾-1-1¼-1½-2

Electric die stock with quick-change die heads. For pipe threads ½–2", 16–50 mm, bolt threads 6–30 mm, ¼–1". For right and left-hand threads. Drive machine with maintenance-free gear, powerful 110 V, 50–60 Hz, 1700 W universal motor, safety switch, power boosting automatic carbon brush adjustment in the direction of rotation selection, right and left-hand rotation. Support bracket for both directions of rotation. REMS eva quick-change die heads for conical pipe threads ISO 7-1, EN 10226 (DIN 2999, BSPT) R ½-¾-1-1¼-1½-2 right. In sturdy steel case.
Art. No. 540020 £ 1,070.00

£ **779.00**

REMS Amigo 2 Set + REMS Aquila 3B

Value £ 1,388.00

Art. No. 540X01 £ **989.00**

German quality product



REMS Tornado – a class on its own.

Automatic clamping chuck
Universal automatic die head
Automatic lubrication cooling

REMS Tornado 2000

Threading machine for pipe threads (1/16) ½–2", 16–63 mm, bolt threads (6) 10–60 mm, ¼–2". With maintenance-free gear, safety foot switch with emergency stop, 2 automatic clamping chucks, automatic lubrication cooling. With tool set, consisting of a universal automatic die head for all threads, including long threads, automatically opening, with automatic thread length for conical threads, dies for conical pipe thread, ISO 7-1, EN 10226 (DIN 2999, BSPT) R ½-¾ and R 1–2 right, pipe cutter, pipe inside burr remover, pressing lever. Height-adjustable material shelf. 110 V, 50–60 Hz, 1700 W universal motor. 53 rpm. Portable version on tripod, with large, removable oil basin and chip tray.
Art. No. 340200

£ 3,130.00

+ 1 REMS Spezial oil 5 l

Art.-No. 140100

£ 43.00

£ 3,173.00

£ **1,849.00**

With universal automatic die head, automatically opening.

German quality product



REMS Magnum – the compact one up to 2". Favourable dimensions, good weight. Excellent round and clean thread.

REMS Magnum 2000 L-T

Threading machine for pipe threads (1/16) 1/2–2", 16–63 mm, bolt threads (6) 8–60 mm, 1/2–2". With maintenance-free gear, safety foot switch with emergency stop, proven, self-reinforcing quick-clamping centring chuck, automatic lubrication cooling. With tool set, consisting of a universal automatic die head for all threads, including long threads, automatically opening, with automatic thread length for conical threads, dies for conical pipe thread ISO 7-1, EN 10226 (DIN 2999, BSPT) R 1/2–3/4 and R 1–2 right, pipe cutter, pipe inside burr remover, pressing lever. Tool shelf. Lightweight version L-T with removable, large oil basin and chip tray. 110 V, 50–60 Hz, 1700 W universal motor. 53 rpm. For workbench, stand, collapsible wheel stand or wheel stand with material shelf. In a carton.

Art. No. 340226 £ 3,160.00

+ REMS wheel stand Art.-No. 344100 £ 291.00

+ 1 REMS Spezial oil 5 l Art.-No. 140100 £ 43.00

£ 3,494.00

£ **2,049.00**

With universal automatic die head, automatically opening.

German quality product



REMS Magnum – the super machine up to 3". Excellent round and clean thread up to 3" by 5 dies.

REMS Magnum 3000 L-T

Threading machine for pipe threads (1/16) 1/2–3", 16–63 mm, bolt threads (6) 20–60 mm, 1/2–2". With maintenance-free gear, safety foot switch with emergency stop, proven, self-reinforcing quick-clamping centring chuck, automatic lubrication cooling. Machine complete with tool sets 1/16–2" and 2 1/2–3", consisting respectively of universal automatic die head for all threads, including long threads, automatically opening, with automatic thread length for conical threads, dies for conical pipe threads ISO 7-1, EN 10226 (DIN 2999, BSPT) R right, pipe cutter, pipe inside burr remover, pressing lever. Tool shelf. Lightweight version L-T with removable, large oil basin and chip tray. 110 V, 50–60 Hz, 1700 W universal motor. 23 rpm. For workbench, stand, collapsible wheel stand or wheel stand with material shelf. In a carton.

Art. No. 380309 £ 4,360.00

+ REMS wheel stand Art.-No. 344100 £ 291.00

+ 1 REMS Spezial oil 5 l Art.-No. 140100 £ 43.00

£ 4,694.00

£ **2,819.00**

With universal automatic die head, automatically opening.

German quality product



REMS Magnum – the super machine up to 4". Excellent round and clean thread up to 4" by 6 dies.

REMS Magnum 4000 L-T

Threading machine for pipe threads (1/16) 1/2–4", 16–63 mm, bolt threads (6) 20–60 mm, 1/2–2". With maintenance-free gear, safety foot switch with emergency stop, proven, self-reinforcing quick-clamping centring chuck, automatic lubrication cooling. With tool sets 1/16–2" and 2 1/2–4", consisting respectively of universal automatic die head for all threads, including long threads, automatically opening, with automatic thread length for conical threads, dies for conical pipe threads ISO 7-1, EN 10226 (DIN 2999, BSPT) R right, pipe cutter, pipe inside burr remover, pressing lever. Tool shelf. Lightweight version L-T with removable, large oil basin and chip tray. 110 V, 50–60 Hz, 1700 W universal motor. 23 rpm. For workbench, stand, collapsible wheel stand or wheel stand with material shelf. In a carton.

Art. No. 380444 £ 5,080.00

+ REMS wheel stand Art.-No. 344100 £ 291.00

+ 1 REMS Spezial oil 5 l Art.-No. 140100 £ 43.00

£ 5,414.00

£ **3,749.00**



REMS SSM 160KS – ideal for the plumber.

Heating element according to DVS. Electronic temperature control. High quality PTFE coating. Closed plane housing.

With quick clamping device, also for angled outputs.

REMS SSM 160KS

Heating element butt welding machine for plastic tubes and mouldings made of PB, PE, PP, PVDF. PE Ø 40–90 mm SDR ≥ 6, PE Ø 40–110 mm SDR ≥ 9, PE Ø 40–125 mm SDR ≥ 11, PE Ø 40–140 mm SDR ≥ 17, PE Ø 40–160 mm SDR ≥ 21. Heating element butt welding device with PTFE-coated heating element 110 V, 50–60 Hz, 1200 W. Adjustable temperature 180–290°C, preset for PE tubes. Electronic temperature control. Protective cover for heating element. Electrical planing device 230 V, 50–60 Hz, 500 W. Pressing device. Quick clamping device, also for inclined outlets, consisting of 2 vices with 2 clamping inserts each Ø 40, 50, 63, 75, 90, 110, 125, 135, 140, 160 mm. 2 pipe rests Ø 160 mm with pipe rest inserts Ø 40, 50, 56, 63, 75, 90, 110, 125, 135, 140 mm. Sheet steel base with installed drawer. Operating key. Closed sheet steel underframe = transport box.

Art. No. 252046 £ 4,840.00

£ **4,099.00**

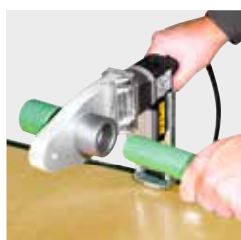

REMS MSG – rational sleeve welding

Heating elements according to DVS
High quality PTFE coating

REMS MSG 63 EE Set 20-25-32

Heating element sleeve welding device for plastic tubes and mouldings made of PB, PE, PP, PVDF. Heating element 110 V, with PTFE-coated heating nozzles, heating sleeves for Ø 20, 25, 32 mm. Fixed temperature for PP tubes set to 260°C, with mechanical temperature regulation. Shelf stand. Holder for workbench for fastening the device in a horizontal or vertical position. Allen key for assembling and disassembling the heating nozzles and heating sleeves.

In sturdy steel case.

Art. No. 256240 £ 630.00

£ **465.00**



With hanging device



Battery
(accessory)

Ultra bright hand and standing lamp. For cordless and mains operation. 145° continuously tiltable.

LED technology with high brilliance

Ergonomically designed handle with soft grip

Battery compartment integrated into the handle Li-Ion 14.4 V batteries or Li-Ion 230 V power supply for mains operation in place of Li-Ion 14.4 V battery as an accessory.

Practical, foldout hanging device

Lamp head continuously tiltable by 145° for better illumination.

Rapid charger for short charging times (1h) as accessory.

No memory effect for maximum battery performance.

REMS cordless LED lamp Li-Ion

Hand and standing lamp for Li-Ion 14.4 V batteries or Li-Ion 230 V power supply.

Without battery, without rapid charger, without power supply. In blister pack.

Art. No. 175200 £ 27.30

£ **24.95**

Sale through specialist dealers.



REMS (UK) Ltd.

Unit 5 · Ash Industrial Estate
Flex Meadow · Harlow · Essex CM19 5TJ
Phone +44 12 79 41 36 98
Fax +44 12 79 41 37 04
www.rems.de
GBR@rem.de

follow us:



www.rems.de



www.youtube.com/remstools



www.facebook.com/remstools



www.twitter.com/remstools